

Technical Manual



MDT Dimming Actuator

AKD-0201.02

AKD-0401.02

Further Documents:

Datasheet:

https://www.mdt.de/EN_Downloads_Datasheets.html

Assembly and Operation Instructions:

https://www.mdt.de/EN_Downloads_Instructions.html

Solution Proposals for MDT products:

https://www.mdt.de/EN_Downloads_Solutions.html

1 Content

1 Content.....	2
2 Overview	4
2.1 Overview devices	4
2.2 Warnings & Instructions for Installation	4
2.2.1 Warnings	4
2.2.2 Exemplary circuit diagrams.....	5
2.3 Structure & Handling	6
2.4 Display LEDs & manual operation	7
2.5 Types of alarms and their correction	7
2.6 Functions	8
2.7 Settings in the ETS software	9
2.8 Commissioning.....	9
3 Communication objects.....	10
3.1 Standard settings of the communications objects.....	10
4 Reference ETS-Parameter	12
4.1 General Settings	12
4.2 Day/Night Object and Location Determination for Time/Date.....	14
4.3 Use of the channels.....	15
4.4 Operation / Basic functions	16
4.4.1 Operation / Basic functions	16
4.4.1.1 Switching.....	16
4.4.1.2 Dimming relative.....	16
4.4.1.3 Dimming absolute	16
4.4.2 Load Type.....	17
4.4.3 Dimming Curve.....	20
4.4.4 Limiting the dimming range of the lamp.....	21
4.4.5 Staircase Light.....	22
4.4.6 Switching On/Off Delay.....	25
4.4.7 Switch on behaviour.....	26
4.4.8 Dimming speed.....	27
4.4.9 Specific dimming settings	28
4.4.9.1 Switch channel off with relative dimming	28
4.4.9.2 Status output	28
4.4.10 Central Objects	29
4.4.11 Block and Force Functions.....	30

4.4.12 Scenes	33
4.4.13 Bit Scenes	37
4.4.14 Time dependent dimming	39
4.4.15 Power Measurement / Diagnosis	41
4.4.15.1 Active power measurement	41
4.4.15.2 Active power meter	42
4.4.16 Diagnosis / Lamp Test.....	43
4.4.16.1 Lamp Test.....	44
4.4.16.2 Error Objects	45
4.4.17 Mains Filter	46
7 Index.....	47
7.1 Register of illustrations	47
7.2 List of tables	48
8 Attachment	49
8.1 Statutory requirements.....	49
8.2 Disposal routine.....	49
8.3 Assemblage.....	49
8.4 History	50

2 Overview

2.1 Overview devices

The description applies to the following dimming actuators (order numbers in bold print):

- **AKD-0201.02** Dimming actuator MRDC, 2-fold, 3 SU, 230V AC – 250W
 - Switching and dimming of light bulbs, HV-halogen lamps, NV- halogen lamps, dimmable energy-saving lamps and LEDs
- **AKD-0401.02** Dimming actuator MRDC, 4-fold, 6 SU, 230V AC – 250W
 - Switching and dimming of light bulbs, HV-halogen lamps, NV- halogen lamps, dimmable energy-saving lamps and LEDs

A separate product database for each device type is available for download on the homepage. The imported product database must match the actuator used.

2.2 Warnings & Instructions for Installation

When installing and connecting dimming actuators, ensure that they are properly connected in accordance with the manufacturer's information in order to avoid damage to the devices and the connected loads. Important warning and installation instructions are compiled in this chapter 2.2 and in chapter 8.3. If, after reading the manual, there are still uncertainties, contact the customer service before installation

See assembly instructions in chapter: 8.3 Assembly

2.2.1 Warnings

Dimmer for conventional loads:



Switching off the load at the secondary winding is forbidden! Because of resonance phenomena, stress intensifications up to 1000V can appear which causes the damage of the dimming actuator. Minimal and maximal loads must be met. The load contains of the transformer and the lamp. In cases of doubt, the primary current consumption must be measured.

Adjustment of the operating mode:



Possibilities of destroying for dimming actuator and connected load, if connected load and adjusted load does not fit to each other!
To avoid this case, check the adjusted dimming mode at changing the connected load as well the connected load at changing the dimming mode.
At changing the load, the load circuit must be unlocked and the adjusted parameter must be checked.

Mixed Loads:



Possibilities of destroying for dimming actuator and connected load, if mixed loads are connected!
Capacitive loads, e.g. electronic transformers, and inductive loads, e.g. inductive transformers, must not be connected together at one channel.
Furthermore inductive loads must not connected together with HV-LED or compact fluorescent light at one channel

2.2.2 Exemplary circuit diagrams

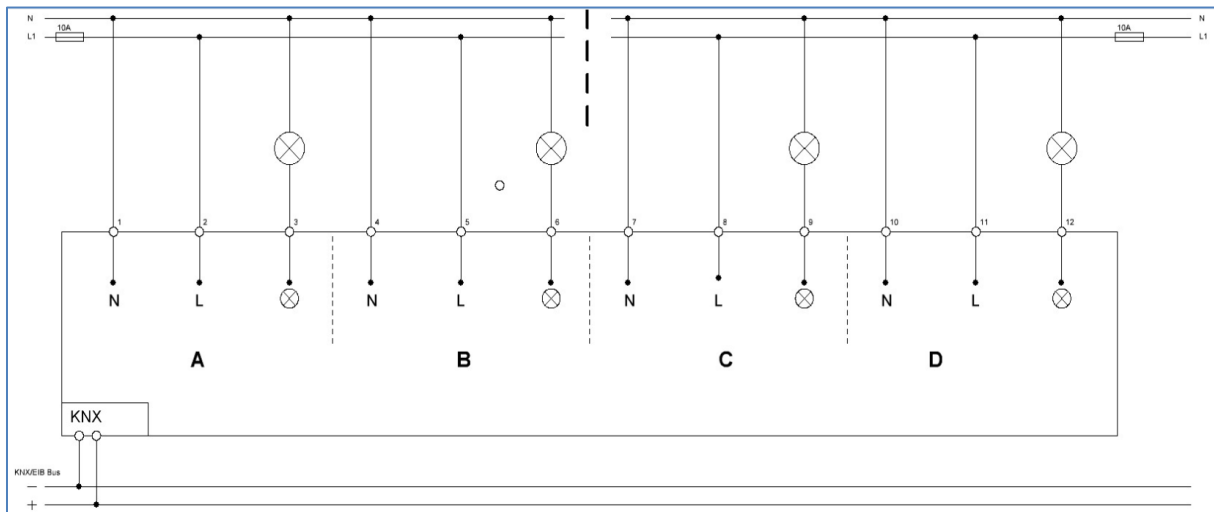

Figure 1: Exemplary circuit diagram AKD-0401.02

In the connection example (Figure 1) different phases L1/L2/L3 can also be used for each channel!

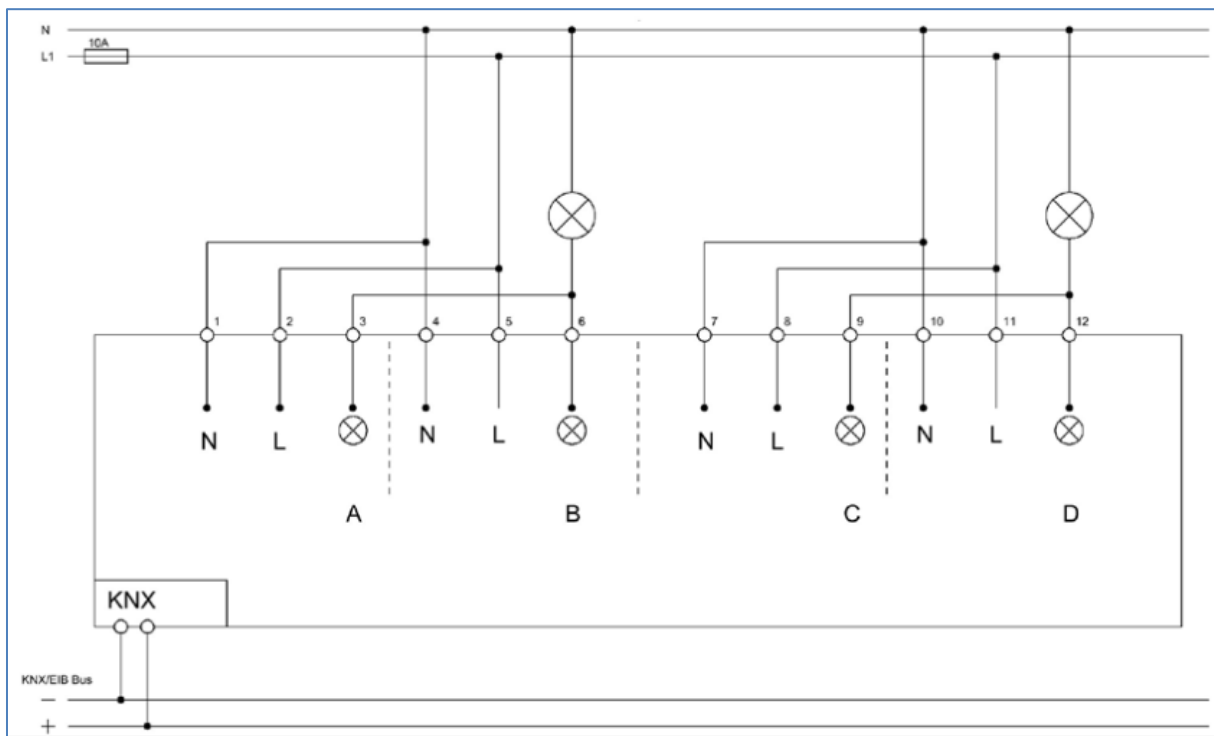

Figure 2: Exemplary circuit diagram AKD-0401.02 (Parallel operation of 2 channels each)

In the connection example (Figure 2), different phases L1/L2/L3 can also be used for the channel pair A/B and channels C and D!

2.3 Structure & Handling

The dimming actuator has a programming button and a programming LED, which indicates that the programming button has been pressed. Bus communication can be established with the bus connecting terminal.

Each channel has a separate supply line (see connection diagram). The neutral conductor must be connected separately for each channel and must not be bridged across the device, see 2.2.2 Connection diagram

The dimming actuator has one green and one red status LED per channel. The green LEDs indicate a switched output. The red LEDs per channel are the LEDs that are responsible for the alarm function. These LEDs indicate the five different alarms with different lighting behaviour. An overview of the display behavior of the LEDs can be found under "2.5 Types of alarms and their correction".

The manual operation function is also described in the following section.

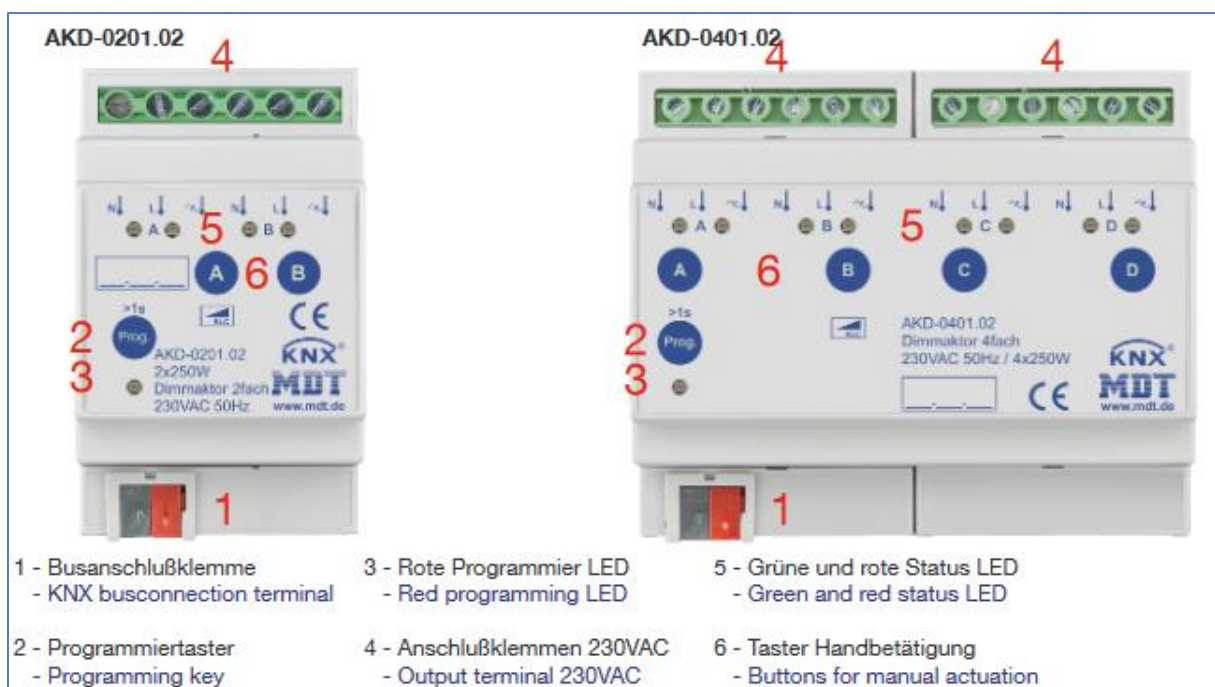

Figure 3: Overview hardware modules

2.4 Display LEDs & manual operation

The individual channels can be switched on and off as well as dimmed up and down manually using the manual control (see picture above). A selected channel is indicated via the status LEDs. These LEDs can indicate the following states:

LED behavior	State of the channel
Green LED on	Channel is switched on
Green LED off	Channel is switched off

Table 1: Display behavior of the green LED

The selected channels can be switched or dimmed via the channel keys. A short press on the channel key switches the channel on/off. With a long keystroke the selected channel can be dimmed. As long as the channel button is pressed, the channel dims up/down. The dimming process is only ended when the channel reaches 100% or when the button is released.

2.5 Types of alarms and their correction

Every channel contains further of a red alarm LED. According to the LED behavior, the following types of alarms are indicated:

LED behavior	State of the channel
Red LED "long on - short off "	2 nd channel at parallel operation is missing
Red LED on	No mains power supply
Red LED flashes 1 x	inductive load detected
Red LED flashes 2 x	Overtemperature
Red LED flashes 3 x	Overcurrent
Red LED flashes 4 x	230V connected but no load

Table 2: Display behavior of the red LED

To eliminate the errors, certain actions must be done, depending to the error type, to eliminate them. These actions are described below:

- **Dimming actuator is in parallel operation and one channel has no voltage; LED long on, short off**
 - Establish voltage supply for the channel according to the circuit diagram.
- **No power supply at the output, LED lights red**
 - Establish voltage supply for the channel according to the circuit diagram.
- **Wrong load at output, LED flashes 1x**
 - Select the correct load for the channel in the ETS software, pay particular attention to the distinction between phase angle and phase section, and reprogram the dimming actuator.
- **Dimming actuator reports overtemperature, LED flashes 2x**
 - Dimmaktor ausschalten bis sich der Aktor abgekühlt hat.
- **Short circuit/overload at output, LED flashes 3x**
 - Remove short circuit/overload at the output. The fault can be eliminated by switching OFF/ON or manual reset. (Prog. Activate mode and press channel key within 5s
- **230VAC is connected but no load at output, LED flashes 4x**
 - Disconnect the output, connect the load and restore the voltage. Output blocked until the next switching command.

Attention: The alarm LEDs always remain on until the next switching or restart and are not deleted automatically!

2.6 Functions

Depending on the device version, two to four channels can be activated or deactivated individually. If one channel is activated, the channel can be further parameterized according to its use. The parameterisation options are identical for all channels of a dimming actuator. The dimming behaviour of the output is described by the selected load type.

- **A variety of output functions**

As standard, the basic functions switching, relative dimming, absolute dimming, status, staircase lighting, disable function, scene and automatic are available in the dimming actuator for each output. Switch-on/switch-off delays and various dimming speeds can be set here. Furthermore, central objects and alarm objects for overcurrent and overtemperature are also available.

- **Extensive dimming functions**

For dimming the lighting you can choose between 5 different dimming curves *linear*, *LED A*, *Led B (recommended)*, *LED C* and *logarithmic*. The *global dimming speeds* are used to set the on/off speeds for day/night operation and the dimming speeds for relative and absolute dimming for all channels. If a different dimming speed is required in a channel, the parameter can be set *individually*. The dimming speed can be changed specifically for this channel. Furthermore, the dimming speed can be set for each scene and a dimming speed can also be indirectly defined under *Transition time to next step*.

- **Time dependent dimming**

The individual channels of the dimming actuators can be dimmed according to the time of day. For this purpose, the value *Time-dependent brightness* is selected when the switch-on behaviour of the channel is parameterised. Ten times with different brightness values are available, for example from 06.00 in the morning with 50%, above 08.00 with 100% and from 20.00 with 80% down to 23.00 to 15%. If the lighting is switched on at 07.00 hours, it starts at 75%. By means of the ten times, an individual day programme can be put together and the lighting automatically always has the right brightness at the right time. Application for example in the bathroom, at night between 00.00 and 05.00 o'clock the light switches ON with only 30% if required.

- **Single operation / parallel operation**

The outputs of the dimming actuator can be wired differently, see 2.2.2 Connection diagram. For the sake of simplicity, please refer to the options in the table:

Order No.	Designation	Channel single operation	Channel parallel operation
AKD-0201.02	Dimming Actuator 2-fold	• 2 x 250W	• 1 x 500W
AKD-0401.02	Dimming Actuator 4-fold	• 4 x 250W	• 1 x 500W + 2 x 250W • 2 x 500W

Table 3: Possible load distribution

- **Long Frame Support**

The dimming actuators support the long frame support. When programming via ETS5, Long Frames (longer telegrams) are sent. These contain more user data per telegram, which significantly reduces the programming time of the LED controllers with the ETS5. You need a programming interface that supports the transmission of long frames. MDT offers the programming interfaces IP Router SCN-IP100.03, IP Interface SCN-IP000.03 and USB Interface SCN-USBR.02

2.7 Settings in the ETS software

Selection in the product database:

Manufacturer: MDT Technologies

Product family: Actuators

Product type: Dimming actuators

Medium Type: Twisted Pair (TP)

Product name: addicted to the used type, e.g.: AKD-0401.02 dimming actuator 4-fold, 6SU, 230V, 250W

Order number: addicted to the used type, e.g.: AKD-0401.02

2.8 Commissioning

After wiring the device, the physical address is assigned and the individual channels are parameterized:

- (1) Connect the interface with the bus, e.g. MDT USB interface
- (2) Set bus power up
- (3) Press the programming button at the device (red programming LED lights)
- (4) Loading the physical address from the ETS software via the interface (red LED turns off as soon as this is successfully completed)
- (5) Loading of the application with requested parameterization
- (6) Connect the mains voltage and switch on
- (7) The dimming actuator needs approx. 10 sec. until it is ready for operation.
- (8) An automatic load test is performed when the unit is started. This test may cause the lamp to flash briefly.
- (9) When the device is ready for operation, the desired function can be checked (also possible with the ETS software.)

3 Communication objects

3.1 Standard settings of the communications objects

The following table shows the standard settings for the communications objects:

Standard Settings									
No.	Name	Function	Lenght	Priority	C	R	W	T	U
0	Channel A	Switch	1 Bit	Low	X		X		
1	Channel A	Staircase light	1 Bit	Low	X		X		
2	Channel A	Staircase light with time	1 Byte/ 2 Byte	Low	X		X		
3	Channel A	Prewarning	1 Bit	Low	X			X	
4	Channel A	Dimming relative Dimming relative (staircase light)	4 Bit	Low	X		X		
5	Channel A	Dimming absolute Dimmingabsolute (staircase light)	1 Byte	Low	X		X		
6	Channel A	State On/Off	1 Bit	Low	X	X		X	
7	Channel A	State of dimming value	1 Byte	Low	X	X		X	
8	Channel A	Block 1	1 Bit / 1 Byte/ 2 Bit	Low	X		X		
9	Channel A	Block 2	1 Bit / 1 Byte/ 2 Bit	Low	X		X		
10	Channel A	Block State	1 Bit	Low	X	X		X	
11	Channel A	Scene	1 Byte	Low	X		X		
12	Channel A	Bit Scene 1	1 Bit	Low	X		X		
13	Channel A	Bit Scene 2	1 Bit	Low	X		X		
14	Channel A	Bit Scene 3	1 Bit	Low	X		X		
15	Channel A	Bit Scene 4	1 Bit	Low	X		X		
16	Channel A	Time dependent dimming – Switch	1 Bit	Low	X		X		
17	Channel A	Time dependent dimming – Status	1 Bit	Low	X	X		X	
18	Channel A	Switch-on value (0% = parameter)	1 Byte	Low	X		X		
	Channel A	Object not in use!!							
20	Channel A	Active power	2 Byte/ 4 Byte	Low	X		X	X	
21	Channel A	Active power meter	4 Byte	Low	X		X	X	
22	Channel A	Reset active power meter	4 Byte	Low	X		X		

23	Channel A	Overtemperature	1 Bit	Low	X	X		X	
24	Channel A	Overload / Short circuit	1 Bit	Low	X	X		X	
25	Channel A	Power error	1 Bit	Low	X	X		X	
26	Channel A	Load failure	1 Bit	Low	X	X		X	
27	Channel A	Start lamp test	1 Bit	Low	X		X		
28	Channel A	Diagnosis text	14 Byte	Low	X	X		X	
+32	next Channel								
64 / 128	Central	Switch	1 Bit	Low	X		X		
65 / 129	Central	Dimming relative	4 Bit	Low	X		X		
66 / 130	Central	Dimming absolute	1 Byte	Low	X		X		
67 / 131	Central	Scene	1 Byte	Low	X		X		
68 / 132	Time	Receive current value	3 Byte	Low	X		X	X	X
69 / 133	Date	Receive current value	3 Byte	Low	X		X	X	X
70 / 134	Date / Time	Receive current value	8 Byte	Low	X		X	X	X
71 / 135	Operation	Ausgang	1 Bit	Low	X	X		X	
72 / 136	Day / Night	Day = 1 / Night = 0 Day = 0 / Night = 1	1 Bit	Low	X		X	X	X

=> Central objects: First object number for 2-fold actuator, second object number for 4-fold actuator

Table 4: Standard settings of the communications objects

The table above shows the preset default settings. The priority of the individual communications objects and the flags can be adjusted by the user as required. The flags assign the communication objects their respective tasks in programming, where C stands for communication, R for read, W for write, T for transmit and U for update.

4 Reference ETS-Parameter

4.1 General Settings

The following figure shows the menu for the general settings (here AKD-0201.02):

Startup delay	<input type="text" value="2"/>	s
Send "Operation" cyclic	<input type="text" value="not active"/>	min
Global dimming speed		
Switching on speed at day	<input type="text" value="2"/>	s
Switching off speed at day	<input type="text" value="2"/>	s
Switching on speed at night	<input type="text" value="2"/>	s
Switching off speed at night	<input type="text" value="2"/>	s
Dimming speed for relative dimming	<input type="text" value="15"/>	s
Dimming speed for absolute dimming	<input type="text" value="10"/>	s
Energy saving mode, switch off LED's of the device after	<input type="text" value="not active"/>	
Day/Night object	<input type="text" value="active, request after reset"/>	
Value for Day/Night	<input checked="" type="radio"/> Day = 1 / Night = 0 <input type="radio"/> Day = 0 / Night = 1	
Toggle light Day/Night	<input checked="" type="radio"/> switched on the next time <input type="radio"/> direct	
Automatic changeover of summertime	<input type="radio"/> not active <input checked="" type="radio"/> active	
Location determination by	<input type="radio"/> coordinates <input checked="" type="radio"/> place	
Country	<input type="text" value="Germany"/>	
Town	<input type="text" value="Engelskirchen"/>	
Time difference from Universal Time (UTC + ...)	<input type="text" value="(UTC +01:00) Amsterdam, Berlin, Bern, Rome, Vienna"/>	
Setting channels	<input checked="" type="radio"/> individual <input type="radio"/> parallel Channel A+B	
Channel A	<input type="radio"/> not active <input checked="" type="radio"/> active	
Channel B	<input type="radio"/> not active <input checked="" type="radio"/> active	

Figure 4: General Settings

The following table shows the possible settings for this menu:

ETS-Text	Dynamic range [default value]	Comment
Startup time	2 - 240 [2s]	Defines the time between a reset and the functional start-up of the device
Send "Operation" cyclic	<ul style="list-style-type: none"> • not active • 1 min – 24 h 	Activation of a cyclic "in operation" telegram
Global dimming speed		
Switch on speed for day	0 - 120 [2s]	Setting the Soft-Start/Soft-Off times for day/night
Switch off speed for day	0 - 120 [2s]	
Switch on speed for night	0 - 120 [2s]	
Switch off speed for night	0 - 120 [2s]	
Dimming speed for relative dimming	1 - 120 [15s]	Setting the dimming speed for dimming via relative commands
Dimming speed for absolute dimming	0 - 120 [10s]	Setting the dimming speed for dimming via absolute commands
Energy saving mode, switch off LEDs on the device after:		
Energy saving mode, switch off LEDs on the device after:	not active 0 – 120s	Setting the time until the LED's on the device switch off
Day/Night object	<ul style="list-style-type: none"> • not active • active, no request • active, request after reset 	Determines whether a day/night object should be used and whether it should be queried in case of a reset
Value for Day/Night	<ul style="list-style-type: none"> • Day = 1 / Night = 0 • Day = 0 / Night = 1 	Polarity of the day/night object
Toggle light Day/Night	<ul style="list-style-type: none"> • Reacts to next switch on • directly 	Definition of when the day/night switchover takes place

Table 5: General Settings

4.2 Day/Night Object and Location Determination for Time/Date

The following settings are available for the day/night object and time:

Energy saving mode, switch off LED's of the device after	not active
Day/Night object	active, request after reset
Value for Day/Night	<input checked="" type="radio"/> Day = 1 / Night = 0 <input type="radio"/> Day = 0 / Night = 1
Toggle light Day/Night	<input checked="" type="radio"/> switched on the next time <input type="radio"/> direct
Automatic changeover of summertime	<input type="radio"/> not active <input checked="" type="radio"/> active
Location determination by	<input type="radio"/> coordinates <input checked="" type="radio"/> place
Country	Germany
Town	Engelskirchen
Time difference from Universal Time (UTC + ...)	(UTC +01:00) Amsterdam, Berlin, Bern, Rome, Vienna

Figure 5: Settings - Day/Night and Time

The **day/night object** is used in the various application settings to create a special switch-on behaviour for day/night or to reduce/increase minimum/maximum brightness. The parameter "**Toggle light day/night**" can be used to define whether the day/night switch has a direct influence or not until the next switch-on. If the switch-over is only activated at the next switch-on, the change of the corresponding values will only be accepted at the next switch-on. For this purpose the channel has to be switched once to 0% / Off. If the changeover is to have a direct effect, where the minimum / maximum values for brightness are adjusted directly and if the last switching command was an ON telegram, the channel is also dimmed according to the switch-on behaviour

The parameter "**Energy saving mode, switch off LEDs on the device after**" can be used to deactivate the LEDs on the device after a certain time. Pressing a key reactivates the LEDs for the set time until they are deactivated again.

The **location determination** is relevant for the calculation of sunrise and sunset times, which can be used in time dependent dimming.

In principle, the receiving time of a master always continues to run internally. In the event of a time changeover after the Central European time changeover for summer time, the device can carry out the time changeover independently, if this is desired via the parameter "**Automatic changeover of summer time**".

The following table shows the associated communication objects

Number	Name	Length	Usage
68 / 132	Time	3 Byte	Receiving the time
69 / 133	Date	3 Bytes	Receiving the date
70 / 134	Date/Time	8 Bytes	Receiving of date and time
72 / 136	Day/Night	1 Bit	Receiving day/night switchover

=> Central objects: First object number for 2-fold actuator, second object number for 4-fold actuator

Table 6: Communication objects - Day/Night and Time/Date

4.3 Use of the channels

The following possibilities for parameterization are available for setting the channels (here AKD-0401.02):

Setting channels	Channel A+B parallel and single Channels C, D	
Channel A + B	<input type="radio"/> not active	<input checked="" type="radio"/> active
Channel C	<input type="radio"/> not active	<input checked="" type="radio"/> active
Channel D	<input type="radio"/> not active	<input checked="" type="radio"/> active

Figure 6: Settings - Use of the channels

Via the parameter "Setting channels" you can select whether channel pairs (A+B and C+D) should be connected in parallel. By connecting 2 channels in parallel, the permissible total current is doubled. If the channels are connected in parallel, they can only be parameterized together. However, it is also possible, for example, to connect channel A+B in parallel and operate channel C/D individually.

The following settings are possible:

- individually (each channel is controlled individually)
- parallel channel A+B and individual channels C,D
- parallel channel A+B and channel C+D
- single channels A,B and parallel channel C+D

However, it is still absolutely necessary to bridge the channels at the terminals with as short connecting cables as possible.

Note: The settings for the 2-fold actuator are reduced accordingly to A and B individually or A/B in parallel.

4.4 Operation / Basic functions

4.4.1 Operation / Basic functions

The basic functions of the normal dimming / switching function are divided into three areas: switching, relative dimming and absolute dimming. As soon as a channel is activated, the communication objects for the basic functions are displayed as standard.

4.4.1.1 Switching

The channel can be switched on or off with the switching command. In addition, there is a message object which indicates the current switching state of the output. This object, state On/Off, can be used for visualisation purposes. If the dimming actuator is to be switched via a binary input, using the toggle function, the object has to be connected to the status object of the binary input, "Value for toggle".

Number	Name	Length	Usage
0	Switch	1 Bit	switches the channel On/Off
6	State On/Off	1 Bit	shows the switching state of the channel

Table 7: Communication objects – Switching

4.4.1.2 Dimming relative

Relative dimming allows continuous dimming. Thus, the connected lamp can be dimmed evenly from 0 to 100% upwards, or dimmed from 100 to 0%. The relative dimming can be stopped at any state. The behaviour of the dimming process can be individually adjusted via additional parameters, such as the dimming speed

Number	Name	Length	Usage
4	Dimming relative	4 Bit	dims the channel evenly up/down

Table 8: Communication objects - Dimming relative

4.4.1.3 Dimming absolute

A discrete brightness level can be set by absolute dimming. By sending a percentage value to the 1-byte "Dimming absolute" command, the output is assigned a specific brightness value.

Number	Name	Length	Usage
5	Dimming absolute	1 Byte	sets a fixed brightness value

Table 9: Communication objects - Dimming absolute

4.4.2 Load Type

For the channel to work properly, the correct load type has to be set for the channel.

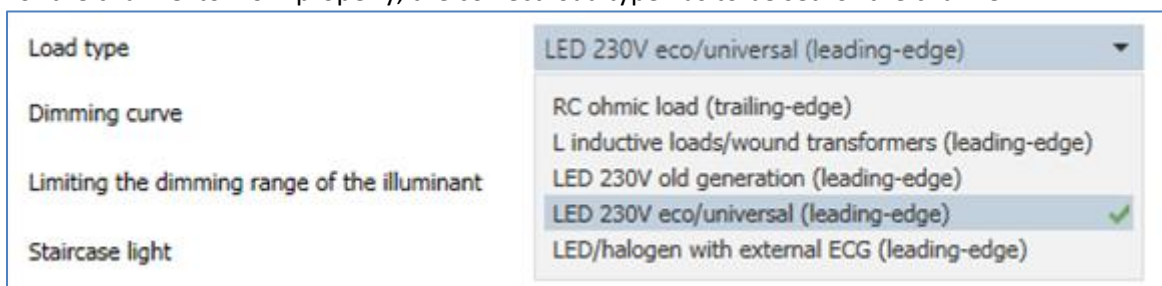

Figure 7: Selection - Load type

The following settings are available for selection:

ETS-text	Dynamic range [default value]	Comment
Load type	<ul style="list-style-type: none"> RC ohmic load (trailing-edge) L inductive loads/wound transformers (leading-edge) LED 230V old generation (leading-edge) LED eco/universal (trailing-edge) LED/Halogen with external ECG (trailing-edge) 	Selection of the load type connected to the respective channel

Table 10: Settings - Load type

For the dimming actuator to dim the channel properly, the connected load type has to be selected in the parameterisation. If the selected load type does not match the connected load type, the channel outputs an error message via the "Overload" object or via the LED on the device itself. The channel does not switch as long as an error message exists. If, after the "Load error" error message, the load is subsequently replaced by hardware, the "Overload" error message remains nevertheless until the channel receives a new switching command and the load detection is restarted.

When selecting the load type, the distinction between phase angle and phase section is particularly important.

The following loads are available for selection and are used here:

- RC ohmic load (trailing-edge)
 - Conventional bulbs, HV Halogen lamps
 - Trailing-edge

- L inductive loads/wound transformers (leading-edge)
 - halogen lamps (low voltage) with wound transformers, fluorescent lamps with conventional electronic ballast, other fluorescent lamps with conventionally wound transformers
 - Leading-edge

- LED 230V old generation (leading-edge)
 - Conventional energy saving lamps (ESL), LEDs with socket (230V)
 - Leading-edge

- LED eco/universal (trailing-edge)
 - Energy saving lamps(ESL) / fluorescent lamps with electronic transformers, LEDs with electronic transformers
 - Halogen lamps (high voltage), halogen lamps (low voltage) with electronic transformer
 - Trailing-edge

- LED/Halogen with external ECG (trailing-edge)
 - Trailing-edge

The following table is to be observed when configuring the load type!

ETS-Parameter	Conventional bulbs, HV Halogen lamps	Low voltage-Halogen. 12V LED via conventional transformer (inductive)	Low voltage-Halogen, 12V-LED via electronical transformer (capacitive)	HV-LED „Retrofit“, Compact fluorescent lamps
RC ohmic load (Trailing-edge)	✓	✗	~	~
L inductive loads/wound transformers (Leading-edge)	~	✓	!	~
LED 230V old generation (Leading-edge)	~	✗	!	✓
LED 230V eco/universal (Trailing-edge)	~	✗	✓	!
LED/Halogen with external ECG (Trailing-edge)	~	✗	✓	~

Table 11: Overview - Setting of load type

Explanation of symbols:

✓	Recommended Mode
~	Usage not recommended, but possible
!	Observe the information on the hardware used regarding the possible dimming principle (leading or trailing edge)!
✗	Warning: Mode can lead to destruction of the device or the hardware used!

Table 12: Explanation of symbols

Configuration notes for LED lamps:

When configuring LED lamps, please pay attention to the transformer's specifications regarding the recommended dimming principle!

If operation is possible in both, leading and trailing edge, both modes may well cause a different behaviour. If the dimming behaviour is not satisfactory, e.g. LED flicker, dimming range too small etc., the dimming mode can be changed by observing the above table.

4.4.3 Dimming Curve

The dimming behaviour can be varied by selecting the respective dimming curve:

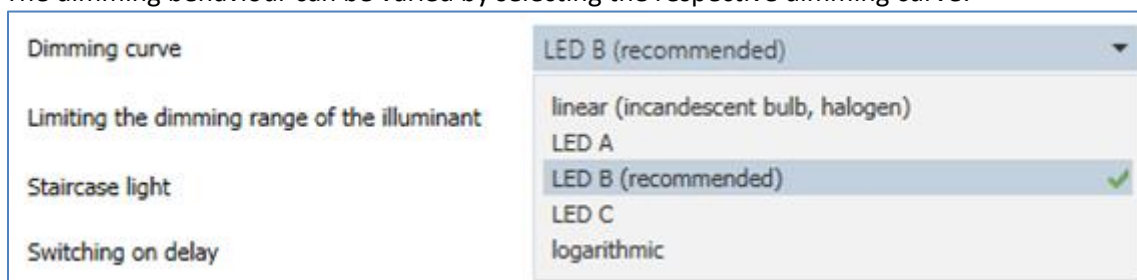

Figure 8: Selection of dimming curve

The following settings are available for the dimming curves:

ETS-Text	Dynamic range [Default value]	Comment
Dimming curve	<ul style="list-style-type: none"> • Linear (Incandescent bulb, Halogen) • LED A • LED B (recommended) • Led C • Logarithmic 	Selection of the characteristic curve for determining the dimming behaviour

Table 13: Settings - Dimming curve

Different luminaire types have different dimming characteristics. However, since a linear dimming behaviour is usually desired, it is necessary to adapt the dimming characteristic, according to which the channel dims, to the lamp used.

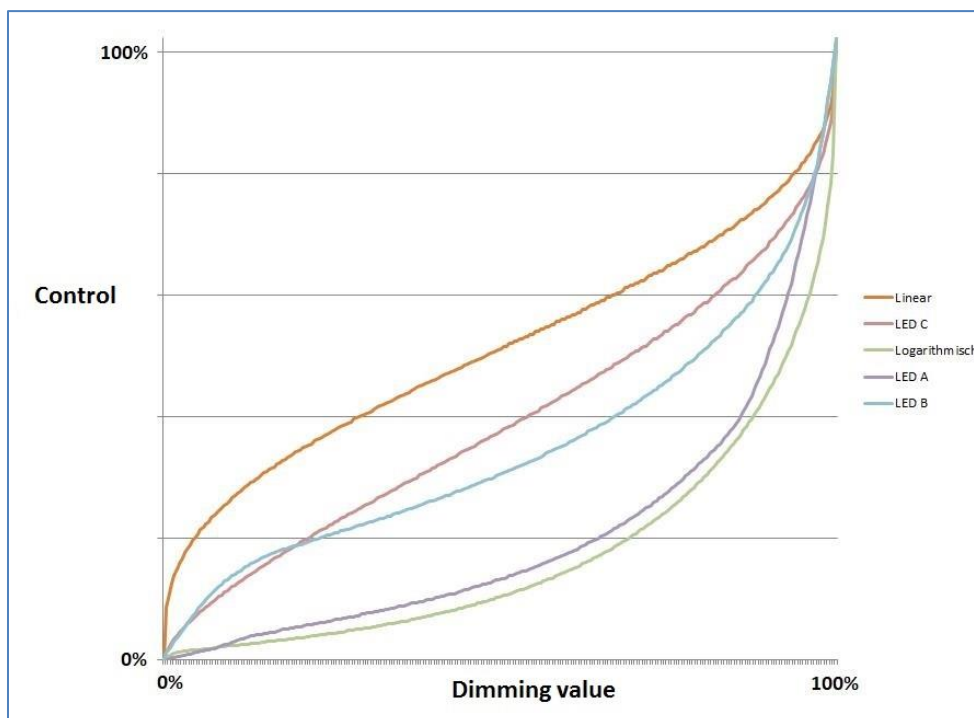
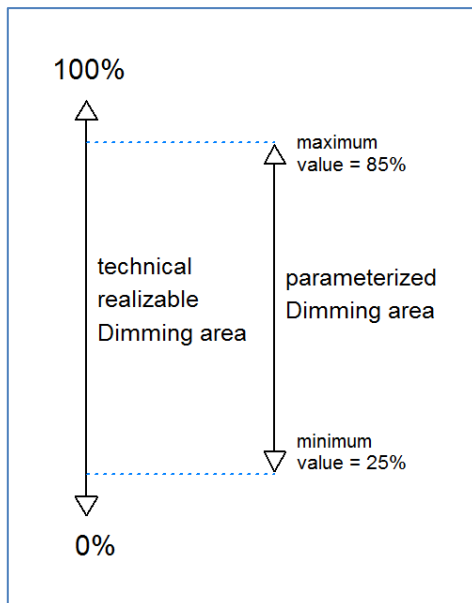

Figure 9: Dimming curves

4.4.4 Limiting the dimming range of the lamp



If the technically possible dimming range (1-100%) is to be limited to a smaller value, this is possible by setting a minimum and maximum brightness value for each channel individually. If the dimming range is limited, the channel will only move within the set limits. This also has consequences for other parameters: if, for example, a maximum brightness value of 85% is set and a switch-on value of 100% is selected, the channel will also switch on at the highest value of the maximum permissible value of 85%. Exceeding this value is no longer possible. The setting of a dimming range is especially useful if certain values should not be reached for technical reasons.

Figure 10: Limitation of dimming range

Example:

minimum brightness value = 25%, maximum brightness value = 85%, switch-on value = 100%

- Telegram value On --> brightness value 85%
- Telegram value 50% --> brightness value 50%
- Telegram value 95% --> brightness value 85%
- Telegram value 15% --> brightness value 25%
- Telegram value Off --> brightness value 0% (Off)

4.4.5 Staircase Light

The staircase lighting function allows the channel to be switched off after a certain time value. To be able to parameterise the staircase lighting function further, it must first be activated. Activation is done in the tab for the respective channel:

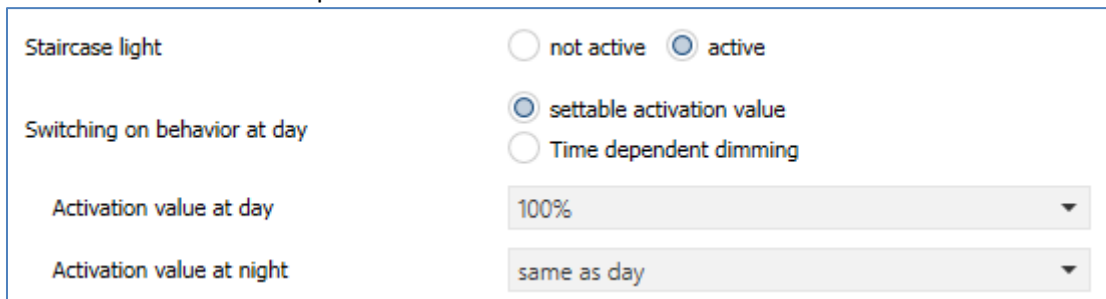

Figure 11: Activation of staircase light

If the staircase lighting function is activated, a new folder appears in the left-hand selection menu, Staircase lighting channel [A-D], in which further parameterisation for the staircase lighting function can be carried out.

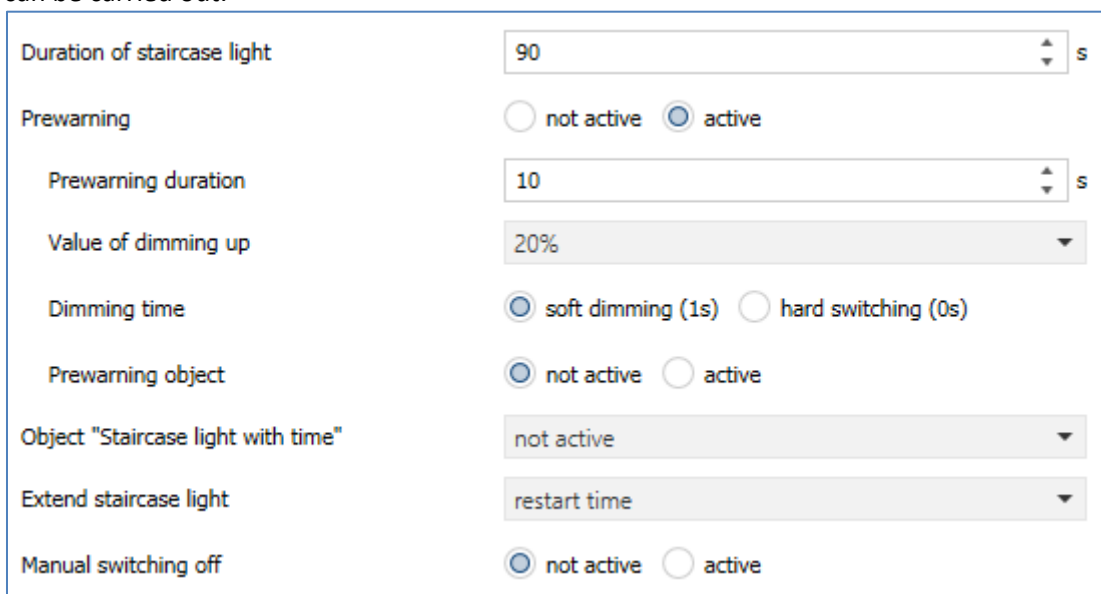

Figure 12: Settings - Staircase light function

The following table shows the setting options for the staircase light function:

ETS-Text	Dynamic range [Default value]	Comment
Switch on behaviour for day	<ul style="list-style-type: none"> • Settable activation value • Time dependent dimming 	Setting the switch-on behaviour for "day"
Activation value for day	0,5 - 100% [100%]	Setting the switch-on value for "day"
Activation value for night	Same as day 0,5 - 100%	Setting the switch-on value for "night"
Duration of staircase light	0 - 14400s [90s]	Duration of the switch-on process

Prewarning	<ul style="list-style-type: none"> • Active • Not active 	Activates the prewarning function
Prewarning duration	0 - 14400s [10s]	Only visible when "Prewarning" is activated. Setting the time for the prewarning
Value for dimming down	1 - 100% [20%] No change	Only visible when "Prewarning" is activated. Value to which the channel is dimmed down after the staircase timer has expired
Time for dimming down	<ul style="list-style-type: none"> • Soft dimming (1s) • Hard dimming (0s) 	Only visible when "Prewarning" is activated. Setting the dimming time
Prewarning object	<ul style="list-style-type: none"> • Active • Not active 	Only visible when "Prewarning" is activated. Activation of a prewarning object
Object "Staircase light with time"	<ul style="list-style-type: none"> • Not active • 1 Byte • 2 Byte 	Activation of an external staircase lighting time via object
Extend staircase light	<ul style="list-style-type: none"> • Not active • Restart time • Add up time 	Activation of a possible extension of the stair light
Manual switching off	<ul style="list-style-type: none"> • Active • Not active 	Activation of switching off before the end of the staircase lighting duration

Table 14: Settings - Staircase light function

The **duration of staircase light** indicates how long the channel should remain switched on after an ON telegram. The channel switches off automatically after the staircase lighting time has elapsed. The parameter **Extend staircase** timer can also be set for the staircase lighting process which determines whether an extension of the staircase timer is possible and whether the time is restarted or added up. If the staircase lighting is controlled absolutely/relatively via dimming, the time is not added up. The **Manual switching off** parameter can be used to decide whether an OFF telegram leads to an immediate switch-off of the channel. The **Prewarning** function can be used to dim the lighting after the staircase timer has ended. This is used to warn that the lighting goes out after the **Prewarning duration** has expired. The lighting is thus dimmed down to the set **Value for dimming down** after the staircase lighting duration has expired and remains switched on for the set prewarning duration after this value is reached. All other actuator controls, e.g. via the switch object, trigger "duration" commands or interrupt the staircase lighting time.

Number	Name	Length	Usage
1	Staircase light	1 Bit	switches on the staircase light function
4	Dimming relative (Staircase light)	4 Bit	used for dimming up and down relatively
5	Dimming absolute (Staircase light)	1Byte	sets a fixed brightness value

Table 15: Communication objects - Staircase light function

The following diagram shows an example of the staircase lighting process with the corresponding dimming times:

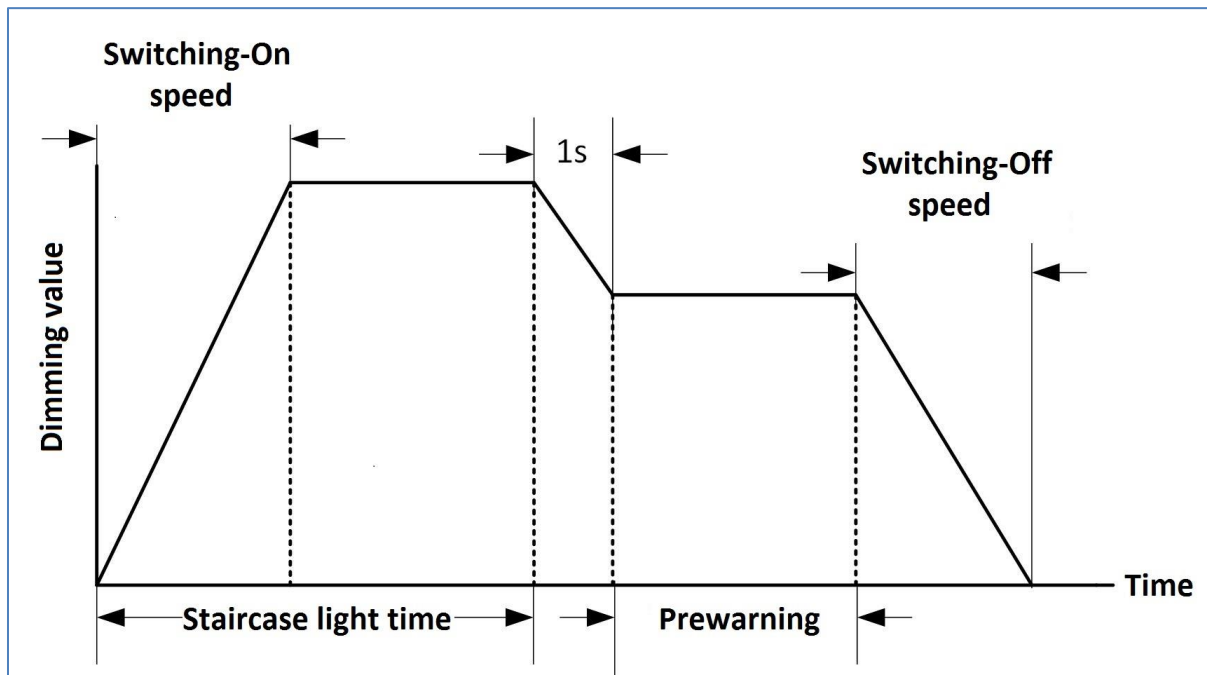

Figure 13: Functional diagram - Staircase light time

4.4.6 Switching On/Off Delay

The ON and OFF delay (OFF delay not available with activated staircase lighting function) enables delayed switching on and off.

The following figure shows the two parameters:

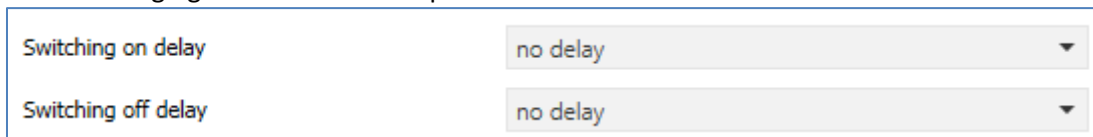

Figure 14: Settings - Switching On/Off delay

The following table shows the possible settings for the two parameters, which are identical for both:

ETS-Text	Dynamic range [Default value]	Comment
Switching on/off delay	no delay, 1s, 5s, 10s, 15s, 20s, 30s, 45s, 60s, 2min, 3min, 4min, 5min, 6min, 7min, 8min, 9min, 10min, 15min, 20min, 30min, 45min, 60min, 90min, 120min, 180min, 240min	Setting of the time by which the switch-on process or the switch-off process should be delayed

Table 16: Settings - Switching On/Off delay

The switch-on delay and the switch-off delay can be used to delay the switching telegrams of the dimming actuator. The delay can occur both during the switch-on process (ON delay) and during the switch-off process (OFF delay). Both functions can also be linked together.

The following program shows how the two functions work which in this example were both activated:

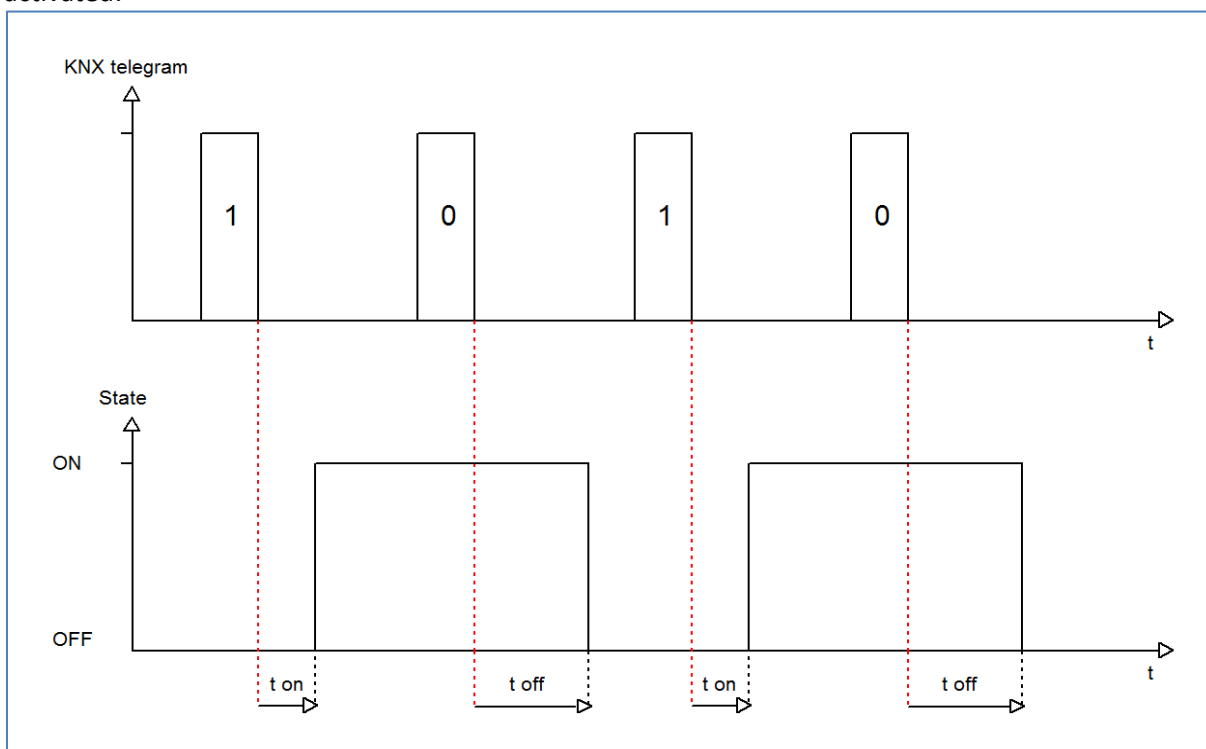

Figure 15: Functional diagram - Switching On/Off delay

4.4.7 Switch on behaviour

The switch on behaviour function can be used to define how the channel is switched on:

Switching on behavior at day	settable activation value
Activation value at day	100%
Change switch-on value via object	not active
Activation value at night	same as day

Figure 16: Settings - Switch on behaviour

The following table shows the possible settings:

ETS-Text	Dynamic range [Default value]	Comment
Switch on behaviour for day	<ul style="list-style-type: none"> ▪ Settable activation value ▪ Last brightness value (Memory) ▪ Time dependent dimming 	Setting of the switch-on behaviour. Last brightness value is not available for the staircase lighting function!
Activation value for day	0,5 - 100% [100%]	Setting of the switch-on value for day/night, which should be dimmed when switching on. Only for the setting: adjustable brightness value!
Activation value for night	Same as day 0,5 - 100%	
Change switch on value via object	<ul style="list-style-type: none"> • not active • active, Day only • active, Night only • active 	Activation of a change of the switch-on value via object
Reset the object value	<ul style="list-style-type: none"> • Device restart • Toggle Day/Night • Hold values (not active) 	Setting which action triggers a "Reset the set switch-on value via object". Only active with setting: Change switch-on value via object!

Table 17: Settings - Switch on behaviour

Via the parameter "**settable activation value**" each channel receives a fixed activation value. The switch-on value covers the entire technically possible range from 0.5-100%. If the dimming range is limited, the dimming actuator switches on at least at the minimum brightness value and at most at the maximum brightness value; irrespective of the set switch-on value.

The "**Last brightness value (Memory)**" parameter causes the dimming actuator to save the value last reached before switching off and to call up this value again when switching on again. If the memory function is activated for day and night is not set to "like day", the last value is only saved if day is active.

The "**Change switch-on value via object**" function can be used to specify a new switch-on value via an object (No.18). Using the "**Reset object value**" parameter, the changed value can be reset to the parameterised switch-on value (device restart or day/night switchover) or it can be retained.

In addition, the channel can start time-dependent light-level control by switching on. The switch-on behaviour can be parameterised separately for day and night

4.4.8 Dimming speed

The dimming speeds can be taken from the global settings or set individually for each channel:

Dimming speed individual global settings

Switching on speed at day 2 ▲▼ s

Switching off speed at day 2 ▲▼ s

Switching on speed at night 2 ▲▼ s

Switching off speed at night 2 ▲▼ s

Dimming speed for relative dimming 15 ▲▼ s

Dimming speed for absolute dimming 10 ▲▼ s

Figure 17: Settings - Dimming speed

The following table shows the available setting options:

ETS-Text	Dynamic range [Default value]	Comment
Dimming speed	<ul style="list-style-type: none"> ▪ individual ▪ global settings 	Setting whether the channel should adopt the global dimming speeds or whether individual times should be set for this channel
Switching on speed for Day	0-120s [2s]	Setting the Soft-Start function when switching on via On/Off in day mode
Switching off speed for Day	0-120s [2s]	Setting the soft-off function when switching on via On/Off in day mode
Switching on speed for Night	0-120s [2s]	Setting the Soft-Start function when switching on via On/Off in night mode
Switching off speed for Night	0-120s [2s]	Setting the soft-off function when switching on via On/Off in night mode
Dimming speed for relative dimming	1-120s [15s]	Setting the speed for relative dimming commands
Dimming speed for absolute dimming	0-120s [10s]	Setting the speed for absolute dimming commands

Table 18: Settings - Dimming speed

4.4.9 Specific dimming settings

4.4.9.1 Switch channel off with relative dimming

The following figure shows the parameter "Switch channel off with relative dimming":

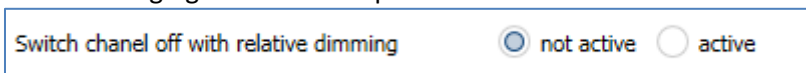

Figure 18: Setting - Switch channel off with relative dimming

The parameter "Switch channel off with relative dimming" can be used to set whether the channel can be switched off via relative dimming. If this parameter is set to inactive, the channel only dims via relative dimming up to the set minimum value and does not switch off the channel.

4.4.9.2 Status output

The following settings are available for the status output of the dimming value

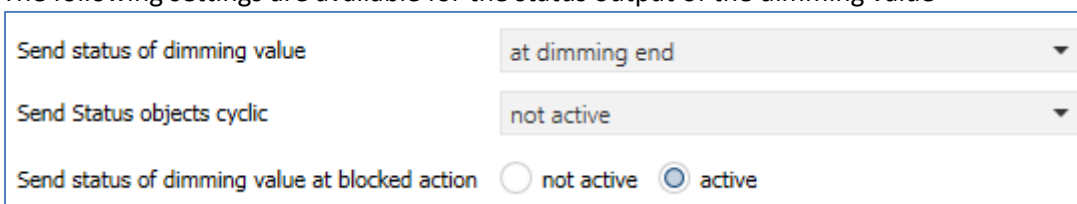

Table 19: Settings - Status output

The following table shows the setting options for the status output of the dimming value:

ETS-Text	Dynamic range [Default value]	Comment
Send state of dimming value	<ul style="list-style-type: none"> at dimming end at change 1% at change 5% at change 10% at change 20% 	Setting when the status of the dimming value is sent
Send Status object cyclic	<p>not active</p> <p>55 min, 10 min, 20 min, 30 min, 60 min</p>	Setting via the possibility to send the status dimming value cyclically and in which time
Send status of dimming value when blocked	<ul style="list-style-type: none"> not active active 	returns the status even if the action is blocked

Table 20: Settings - Send status of dimming value

The communication object for the current dimming value is permanently displayed. The 1-byte size object then outputs the current dimming value when a change is made, depending on the parameterisation.

Using the "Send status dimming value when action is blocked" parameter, the status output can also be activated for a blocked channel, for example to report this back to a visual display.

Number	Name	Length	Usage
7	State of dimming value	1 Byte	indicates the current dimming value in %

Table 21: Communication object - State of dimming value

4.4.10 Central Objects

For each channel it can be defined individually whether the channel should react to the central objects. The activation is carried out as follows:

Central objects	<input type="radio"/> not active	<input checked="" type="radio"/> active
Switching off	<input type="radio"/> not active	<input checked="" type="radio"/> active
Switching on	<input type="radio"/> not active	<input checked="" type="radio"/> active
Relative dimming	<input type="radio"/> not active	<input checked="" type="radio"/> active
Absolute dimming	<input type="radio"/> not active	<input checked="" type="radio"/> active
Scenes	<input type="radio"/> not active	<input checked="" type="radio"/> active

Figure 19: Settings - Central objects

If the function is activated for a channel, the channel reacts to the central objects with its individually parameterized settings.

ETS-Text	Dynamic range [Default value]	Comment
Central objects	<ul style="list-style-type: none"> not active active 	Activates/deactivates the central objects
Switching off	<ul style="list-style-type: none"> not active active 	Determines whether this channel can be switched off via central object
Switching on	<ul style="list-style-type: none"> not active active 	Determines whether this channel can be switched on via central object
Relative dimming	<ul style="list-style-type: none"> not active active 	Determines whether this channel can be dimmed relatively via central object
Absolute dimming	<ul style="list-style-type: none"> not active active 	Determines whether this channel can be dimmed absolutely via central object
Scenes	<ul style="list-style-type: none"> not active active 	Determines whether the scene call via central object is enabled

Table 22: Settings - Central objects

The following table shows the associated communications objects:

Number	Name	Length	Usage
64 / 128	Switch	1 Bit	Switches all channels with activated central function on/off
65 / 129	Dimming relative	4 Bit	Dims all channels with activated central function evenly up/down
66 / 130	Dimming absolute	1 Byte	Sets an absolute value to all channels with activated central function
67 / 131	Scene	1 Byte	Calls up a scene for all channels with activated central function

First number for 2-fold actuator, second number for 4-fold actuator

Table 23: Communication objects - Central objects

4.4.11 Block and Force Functions

The following figure shows the setting options available in the Block and Force functions menu:

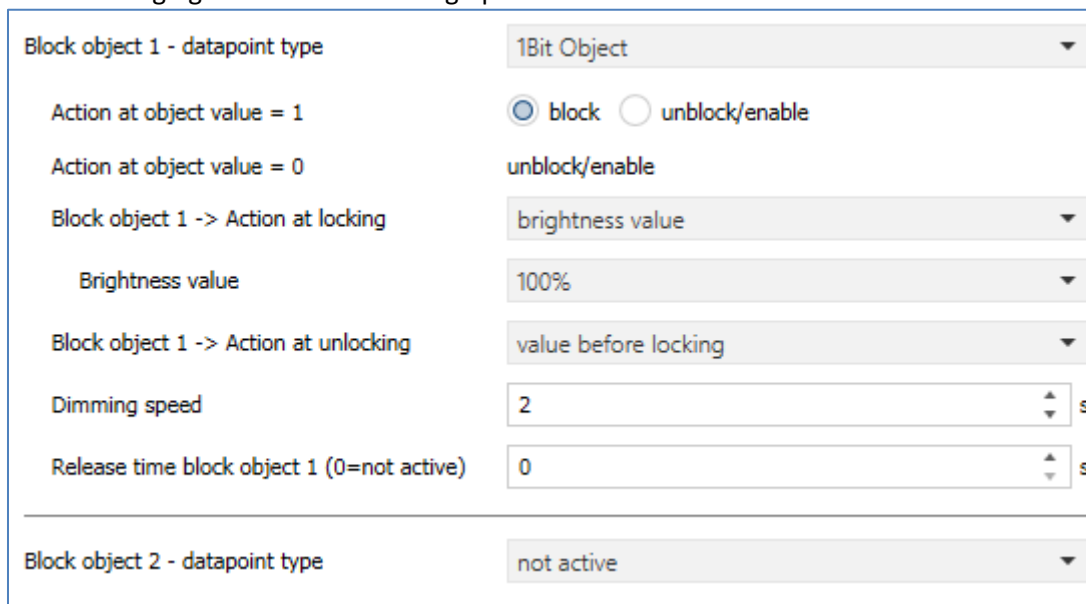

Figure 20: Settings - Block and Force functions

Each channel has 2 independent blocking functions, whereby blocking function 1 has a higher priority than blocking function 2.

Each blocking function can be activated/deactivated by a 1-bit object, a 2-bit object or a 1-byte object.

The following table shows the available setting options for the various blocks:

ETS-Text	Dynamic range [Default value]	Comment
Block object 1/2 – Datapoint type	<ul style="list-style-type: none"> 1 Bit Object 	Setting the data point type for lock object 1/2 to 1 Bit
Action at object value = 1	<ul style="list-style-type: none"> block unblock/enable 	Setting whether to block or unblock at value 1
Action at object value = 0	is determined automatically after selecting the action at object value = 1	Setting whether to block or unblock at value 0; is automatically defined by action at value = 1
Block object 1/2 – Datapoint type	<ul style="list-style-type: none"> 2 Bit Object 	Setting the data point type for lock object 1/2 to 2 Bit
Action at object value Force ON	Block	With object value Force ON the channel is always blocked; not adjustable
Action at object value Force OFF	<ul style="list-style-type: none"> Block -> Off No change 	Setting whether the lock is to be unlocked or not to be changed when "Force Off" is selected
Action at object value Force End	unblock/enable	With object value "Force end" the channel is always unlocked; not adjustable

Block object 1/2 – Datapoint type	<ul style="list-style-type: none"> • 1 Byte Object 	Setting the data point type for lock object 1/2 to 1 Byte
Action at Dimming value = 0%	entsperren/freigeben	Sperre aktiv, wenn Dimmwert ungleich 0%. Bei Objektwert 0% wird der Kanal immer entsperrt. Nicht einstellbar
The following settings are valid for all datapoint types		
Block object 1/2 -> Action at locking	<ul style="list-style-type: none"> • Deactivation • Activation value (Day/Night) • Hold value / no change • Brightness value • Time dependent dimming • Disable time dependent dimming 	Setting the action when locking
Brightness value	10-100% [100%]	Setting of a fixed brightness value, only available if <i>Action at locking</i> is set to <i>brightness value</i>
Block object 1/2 -> Action at unlocking	<ul style="list-style-type: none"> • Deactivation • Activation value (Day/Night) • Hold value / no change • Brightness value • Update value • Value before locking • Time dependent dimming • Disable time dependent dimming 	Setting the action when unlocking
Brightness value	10-100% [10%]	Setting of a fixed brightness value, only available if <i>Action at unlocking</i> is set to <i>brightness value</i>
Dimming speed	0 - 120 [2s]	Setting the dimming speed for calling up a brightness value
Release time block object 1/2 (0 = not active)	0 - 32000 [0s]	Setting whether the locking function is automatically reset after a defined time

Table 24: Settings - Block and Force functions

Block functions 1 and 2 can be triggered with 3 different data point types. The behavior is then as follows:

- **1 Bit Object**
It can be freely determined whether the channel is to be locked/unlocked with the "0" or the "1". The actions for locking/unlocking can also be set.
- **2 Bit Object**
By means of 2 bit forced control, the channel is disabled at object value forced ON (11). With object value Override end (00), the channel is unlocked. The action for force OFF (10) can be set to "Lock OFF" or "No change".
- **1 Byte dimming value**
By means of a 1-byte object, the channel is set to the corresponding value via a dimming value >0% and disabled. The value 0% unblocks the channel again.

The following actions can be defined for locking (no action can be defined for the locking function via 1 byte object, since the channel is set to the transmitted value here) and unlocking:

- **Deactivation**
The channel is switched off.
- **Activation value (Day/Night)**
The channel is set to the currently valid switch-on value (depending on whether day or night).
- **Hold value / no change**
The channel remains in its current state.
- **Brightness value**
A freely adjustable brightness value (0-100%) is controlled.
- **Update value**
The value of the channel is updated, i.e. it retrieves the actions that were sent during the lockout.
- **Value before locking**
The channel restores the value it had before the lock function.
- **Time dependent dimming**
The channel starts the time dependent dimming.
- **Disable time dependent dimming**
The channel switches off the time dependent dimming.

The following table shows the central objects:

Number	Name	Length	Usage
8	Block 1	1 Bit/ 2 Bit/ 1 Byte	Lock object 1 for channel A, type depends on the data point settings for the first lock object
9	Block 2	1 Bit/ 2 Bit/ 1 Byte	Lock object 2 for channel A, type depends on the data point settings for the first lock object
10	Block state	1 Bit	Transmits a 1 when channel is locked and a 0 when the channel is not locked

Table 25: Communication objects - Block and Force Functions

4.4.12 Scenes

If room functions of different trades (e.g. lighting, heating, roller shutters) are to be changed simultaneously at the push of a button or with an operating command, the scene function is a good choice. By calling up a scene, you can, for example, switch or dim the room lighting to a desired value, move the blinds to a desired position and turn the slats, set the heating control to daytime operation and switch on the power supply for the sockets in a room. The telegrams of these functions can have not only different formats but also values with different meanings (e.g. "0" for lighting OFF and for OPEN blinds). Without the scene functions, you would have to send a separate telegram to each actuator to obtain the same setting

The scene function of the dimming actuator can be used to integrate the channels into a scene control. To do this, the value has to be assigned to the corresponding memory location (scene A-H). Up to 8 scenes can be programmed per channel. If the scene function is activated in the channel, the associated sub-menu appears. The individual scenes can be activated here and values, scene numbers and the ON/OFF memory function can be set.

Scenes are activated by receiving their scene number on the scene object. If the save function is activated in the scene, the current channel values are saved with the object value of the scene. The communication objects of scenes always have a size of 1 byte

The following figure shows the setting for activating the scene function:



Figure 21: Activation - Scene

The following table shows the associated communication object for an activated scene:

Number	Name	Length	Usage
9	Scene	1 Byte	Calling up the respective scene

Table 26: Communication object - scene

The following figure shows the setting options in the submenu Scene:

Save scene	active
Scene number A	1
Action	brightness value
Brightness value	100%
Dimming speed	5 s
Scene number B	not active
Scene number C	not active
Scene number D	not active
Scene number E	not active
Scene number F	not active
Scene number G	not active
Scene number H	not active

Figure 22: Settings - Submenu Scene

The following table shows the setting options for an activated scene function:

ETS-Text	Dynamic range [Default value]	Comment
Save scene	<ul style="list-style-type: none"> • not active • active • keep learned scene (no takeover of parameter) 	Setting whether the current value of the scene can be saved (only for action: brightness value) and whether the value is reset after reprogramming. Save scene active: Stored value is reset after reprogramming. Keep learned scene: Stored value is retained after reprogramming
Scene number A....H	<ul style="list-style-type: none"> • not active • 1 - 64 	Setting the scene number for the scene call
Action	<ul style="list-style-type: none"> ▪ Deactivation ▪ Activation value (Day/Night) ▪ Brightness value ▪ Time dependent dimming ▪ Disable time dependent dimming ▪ Enable Block 1 ▪ Enable Block 2 ▪ Unlocking 	Setting the action for scene call up
Brightness value	0 - 100% [100%]	Setting the brightness value if a fixed brightness value is to be called
Dimming speed	0 - 14400 [5s]	Setting the dimming speed for scene call up

Table 27: Settings - Submenu Scene

To call up a scene or save a new value for the scene, the corresponding code is sent to the associated communication object for the scene:

Scene	Call up		Save	
	Hex.	Dec.	Hex.	Dec.
1	0x00	0	0x80	128
2	0x01	1	0x81	129
3	0x02	2	0x82	130
4	0x03	3	0x83	131
5	0x04	4	0x84	132
6	0x05	5	0x85	133
7	0x06	6	0x86	134
8	0x07	7	0x87	135
9	0x08	8	0x88	136
10	0x09	9	0x89	137
11	0x0A	10	0x8A	138
12	0x0B	11	0x8B	139
13	0x0C	12	0x8C	140
14	0x0D	13	0x8D	141
15	0x0E	14	0x8E	142
16	0x0F	15	0x8F	143
17	0x10	16	0x90	144
18	0x11	17	0x91	145
19	0x12	18	0x92	146
20	0x13	19	0x93	147
21	0x14	20	0x94	148
22	0x15	21	0x95	149
23	0x16	22	0x96	150
24	0x17	23	0x97	151
25	0x18	24	0x98	152
26	0x19	25	0x99	153
27	0x1A	26	0x9A	154
28	0x1B	27	0x9B	155
29	0x1C	28	0x9C	156
30	0x1D	29	0x9D	157
31	0x1E	30	0x9E	158
32	0x1F	31	0x9F	159

Table 28: Scene call up and save

4.4.13 Bit Scenes

The following figure shows the setting options in the submenu Bit scenes:

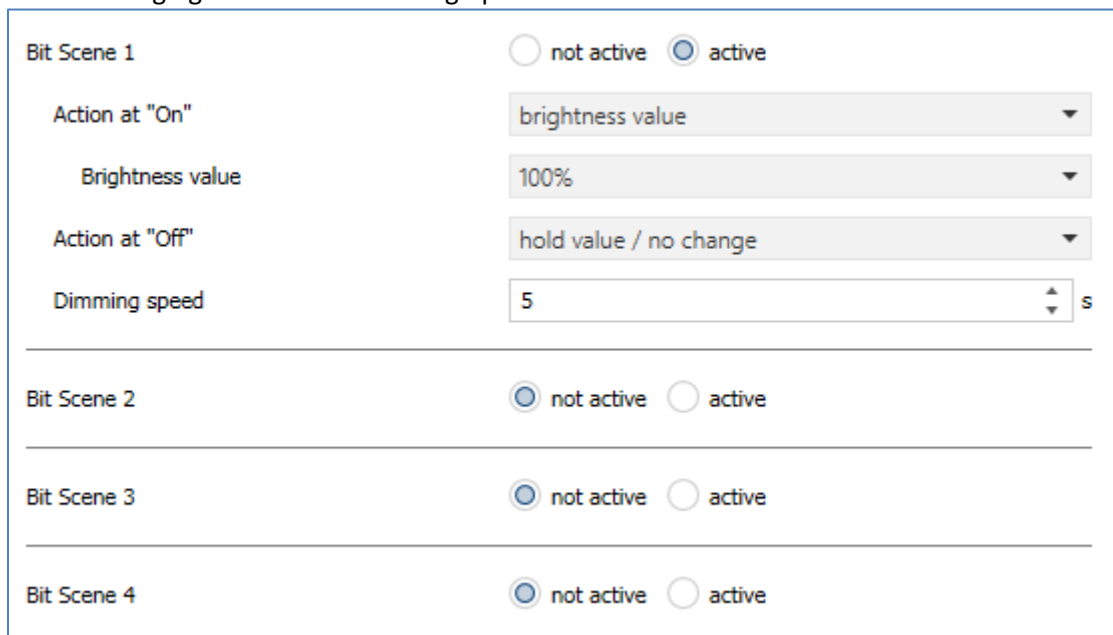

Figure 23: Settings - Bit Scenes

The functionality of the bit scenes is similar to that of the normal scene function, except that an action can be triggered for both the value 0 and the value 1. The bit scenes can be triggered via simple switching functions.

The following settings are available for the bit scenes:

ETS-Text	Dynamic range [Default value]	Comment
Action at „On“/ „Off“	<ul style="list-style-type: none"> ▪ Deactivation ▪ Activation value (Day/Night) ▪ Hold value / no change ▪ Brightness value ▪ Time dependent dimming ▪ Disable time dependent dimming ▪ Enable Block 1 ▪ Enable Block 2 ▪ Unlocking 	Setting the action for scene call up
Brightness value	0 - 100% [100%]	Setting the brightness value if a fixed brightness value is to be called
Dimming speed	0 - 14400 [5s]	Setting the dimming speed for scene call up

Table 29: Settings - Bit Scenes

The following actions can be performed for the value 0/1:

- **Deactivation**
The channel is switched off.
- **Activation value (Day/Night)**
The channel is set to the currently valid switch-on value (for day or night).
- **Hold value / no change**
The channel remains in its current state.
- **Brightness value**
A freely adjustable brightness value (0-100%) is controlled.
- **Time dependent dimming**
The channel starts the time dependent dimming.
- **Disable time dependent dimming**
The channel switches off the time dependent dimming.
- **Enable Block 1**
Block 1 is activated.
- **Enable Block 2**
Block 2 is activated.
- **Unlocking**
The channel is unlocked.

The following table shows the associated communication object for an activated scene:

Number	Name	Length	Usage
12	Bit Scene 1	1 Bit	Activating/deactivating the Bit Scene 1
13	Bit Scene 2	1 Bit	Activating/deactivating the Bit Scene 2
14	Bit Scene 3	1 Bit	Activating/deactivating the Bit Scene 3
15	Bit Scene 4	1 Bit	Activating/deactivating the Bit Scene 4

Table 30: Communication object - Bit scenes

4.4.14 Time dependent dimming

Each channel can be automatically dimmed during the course of the day by time or sunrise/sunset.

The following picture shows the menu Time dependent dimming:

Switching times	<input checked="" type="radio"/> Time <input type="radio"/> sunrise / sunset
Action for brightness change via relative or absolute dimming	Time dependent dimming is interrupted
Fallback time of brightness	no fallback
Behavior at control object "Off"	<input type="radio"/> stop sequence <input checked="" type="radio"/> deactivation
<hr/>	
Time 1	06:00
Brightness	50%
Time 2	08:00
Brightness	100%
Time 3	10:00
Brightness	100%

Figure 24: Settings - Submenu Time dependent dimming

Folgende Einstellungen sind für das uhrzeitabhängige Dimmen verfügbar:

ETS-Text	Dynamic range [Default value]	Comment
Switching times	<ul style="list-style-type: none"> ▪ Time ▪ Sunrise / sunset 	Setting after which time specification is to be dimmed
Action for brightness change via relative or absolute dimming	Time dependent dimming is interrupted	If the brightness is changed during time-dependent dimming via relative or absolute dimming commands, time-dependent dimming is interrupted. This setting cannot be changed!
Fallback time of brightness	No Fallback 1 min – 12 h	Setting the release time when the channel returns to time-dependent dimming after a change in brightness (see previous point).
Behaviour at control object „Off“	<ul style="list-style-type: none"> ▪ Stop sequence ▪ Deactivation 	Setting whether the channel is switched off with the control object or only the sequence is stopped
Time 1 - 10	Fixed settable time from 0-24h or time depending on sunrise/sunset	Setting the time for the respective control point. Depending on the "Switching times" parameter, fixed times or times depending on sunrise/sunset can be set here
Brightness	0 - 100%	Setting the brightness to be controlled for the respective time

Table 31: Settings - Submenu Time dependent dimming

Due to the time dependent dimming a dimming process can be realized over a whole day. The channel adjusts the brightness for this channel depending on the time. Time-dependent dimming can be carried out either on the basis of sunrise and sunset times (which the dimming actuator calculates itself by entering the time/date) or on the basis of fixed times. For this purpose, 10 control points (time + brightness value to be controlled) can be defined. The set brightness is then reached at the set time. The dimming actuator interpolates between the control points, i.e. if, for example, a brightness value of 50 % is set for 8:00 and a brightness value of 75 % for 10:00, the channel will dim slowly from 50 % to 75 % within these 2 hours.

If the brightness value is changed during time-dependent dimming via relative/absolute dimming commands, time-dependent dimming is interrupted. In the Brightness release time parameter, you can set whether and after what time the brightness is automatically reset to the parameter value. If the release time is active, time-dependent dimming can be stopped via the object Time-dependent dimming - switching, scene or bit scene

The following table shows the associated communications objects:

Number	Name	Length	Usage
16	Time dependent dimming - Switching	1 Bit	Activating/deactivating time dependent dimming
17	Time dependent dimming - Status	1 Bit	Output of the status whether time dependent dimming is active or not

Table 32: Communication objects - Time dependent dimming

4.4.15 Power Measurement / Diagnosis

4.4.15.1 Active power measurement

The following picture shows the menu for active power measurement:

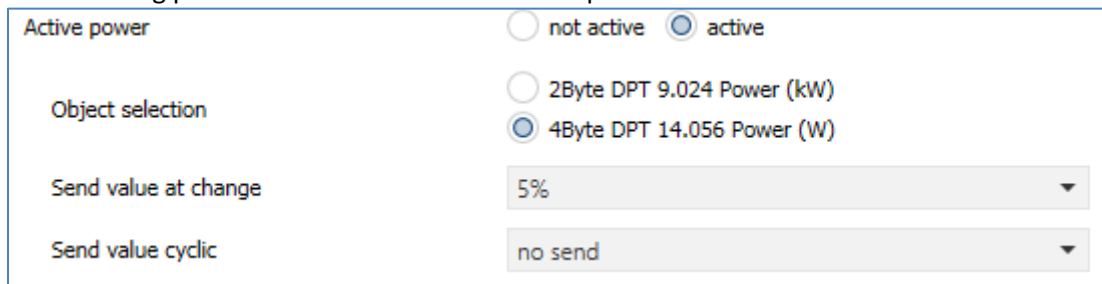

Figure 25: Settings - Active power measurement

The following settings can be made for active power measurement:

ETS-Text	Dynamic range [Default value]	Comment
Active power	<ul style="list-style-type: none"> ▪ Not active ▪ Active 	Activation / deactivation of active power measurement
Object selection	<ul style="list-style-type: none"> ▪ 2 Byte ▪ 4 Byte 	Only visible when "Active power" is activated. Setting the object size of the measured value
Send value at change of	<ul style="list-style-type: none"> ▪ Not active ▪ 5% ▪ 6% ▪ 7% ▪ 8% ▪ 9% ▪ 10% 	Only visible when "Active power" is activated. Activation and setting of sending condition at value change
Send value cyclic	<p style="text-align: center;">No send 5 min – 24 h</p>	Only visible when "Active power" is activated. Activation and setting of the time interval in which cyclical sending takes place

Table 33: Settings - Active power measurement

The following table shows the associated communications objects:

Number	Name	Length	Usage
20	Active power	2 Byte 4 Byte	Output of the currently measured active power

Table 34: Communication object - Active power measurement

The active power measurement enables the output of the real active power by measuring current and voltage simultaneously. The output value is thus no longer a "theoretical" power at nominal voltage, but the actual power. The measured power of the actuator channel can be output via object *Active power* and thus display the currently connected load.

4.4.15.2 Active power meter

The following picture shows the menu for active power measurement:

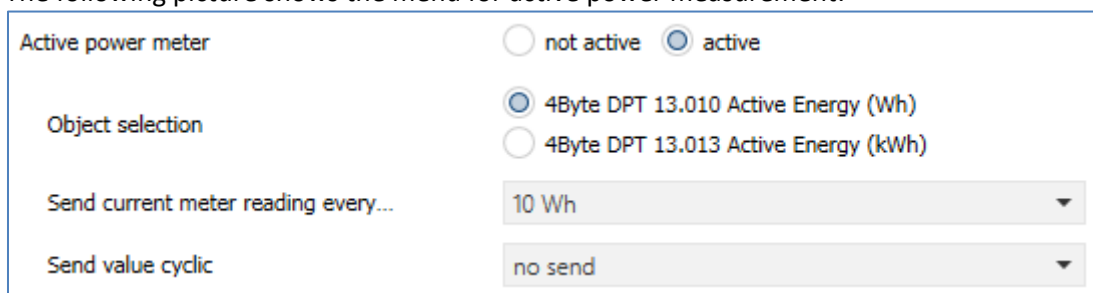

Figure 26: Settings - Active power meter

The following settings can be made for the active power meter:

ETS-Text	Dynamic range [Default value]	Comment
Active power meter	<ul style="list-style-type: none"> ▪ Not active ▪ Active 	Activation / deactivation of active power meter
Object selection	<ul style="list-style-type: none"> ▪ 4 Byte (Wh) ▪ 4 Byte (kWh) 	Only visible when "Active power meter" is activated. Setting the object size of the measured value
Send current meter reading every...	<p>10 Wh – 5000 WH [10 Wh]</p> <p>1 kWh – 5000kWh [1 kWh]</p>	Only visible when "Active power meter" is activated. Activating and setting the sending condition for the counter reading. Value range depending on object selection
Send value cyclic	<p>No send</p> <p>5 min – 24 h</p>	Only visible when "Active power meter" is activated. Activation and setting of the time interval in which cyclical sending takes place

Table 35: Settings - Active power meter

The following table shows the associated communications objects:

Number	Name	Length	Usage
21	Active power meter	4 Byte (Wh) 4 Byte (kWh)	Output of the current counter value
22	Reset Active power meter	1 Bit	Resetting the active power meter

Table 36: Communication objects - Active power meter

The active power meter is available for counting the consumed power and can display both watt-hours and kilowatt-hours depending on the parameterization.

4.4.16 Diagnosis / Lamp Test

The following figure shows the setting options for activating the diagnosis:



Figure 27: Activation - Diagnosis

The following table shows the corresponding communication object for the diagnosis:

Number	Name	Length	Usage
28	Diagnose	14 Bytes	Output of the diagnosis text as "plain text".

Table 37: Communication object - Diagnosis

The diagnostics as plain text outputs the last executed action as 14 byte string and can be used for diagnostic purposes.

The following diagnostic texts can be displayed:

Diagnosis texts	Bedeutung
Power_OK	230V power supply OK
Power_Fail	230V power supply faulty
Overload	Channel has detected overload/overcurrent
Overload_I	Channel has detected overcurrent
Overload_P	Channel has detected overload
Tempfail	Channel has detected an overtemperature
Noload	No load connected to channel (check only at restart)
Loadcontrol_Info_I	Display of the percentage current load of the channel (output after manual lamp test)
Loadcontrol_Info_P	Display of the percentage power utilization of the channel (output after manual lamp test)
Datetime_Fail	Actuator has not received a current time and date (Important for time-dependent dimming)
Datetime_OK	Actuator has received the current time and date (Important for time-dependent dimming)

Table 38: Diagnosis texts

4.4.16.1 Lamp Test

By activating the diagnostic function, the lamp test object is also enabled.

The following table shows the corresponding communication object for the lamp test:

Number	Name	Length	Usage
27	Start lamp test	1 Bit	Start of the lamp test

Table 39: Communication object - Start lamp test

The lamp test is started with the value 1 on the 1 bit object *lamp test*. During the lamp test, the peak current and peak power are determined by controlling different brightness levels and output as a result of the diagnostic object *Load in percent*.

This function can be used to determine the maximum number of lamps for a dimming channel.

-	7/0/0	Leuchtmitteltest Starten	6	GroupValueW... 1.010 Start... \$01 Start
AKD-0401.02 Dimmaktor 4-fach	7/0/1	Diagnosetext	6	GroupValueW... 16.001 Zei... 49 4E 46 4F 3A 50 6F 77 65 72 20 4F 68 20 INFO:Power Ok
AKD-0401.02 Dimmaktor 4-fach	7/0/1	Diagnosetext	6	GroupValueW... 16.001 Zei... 4C 45 44 5F 41 62 5F 32 30 30 57 00 00 00 LED_Ab_200W
AKD-0401.02 Dimmaktor 4-fach	7/0/1	Diagnosetext	6	GroupValueW... 16.001 Zei... 49 4E 46 4F 3A 20 30 33 25 20 50 20 20 20 INFO: 03% P

Figure 28: Lamp test

The test takes about 30 seconds and has given the following information about the "diagnosis":

The message "Info Power Ok" shows that the channel is powered.

"LED_Ab_200W" shows that the channel is working as trailing-edge dimmer (Ab) and can be loaded with maximum 200W. At the end of the test the percentage load of the channel is displayed. In this example it is 2%. With this value the maximum number of lamps can be calculated.

4.4.16.2 Error Objects

The following figure shows the menu for the error objects:

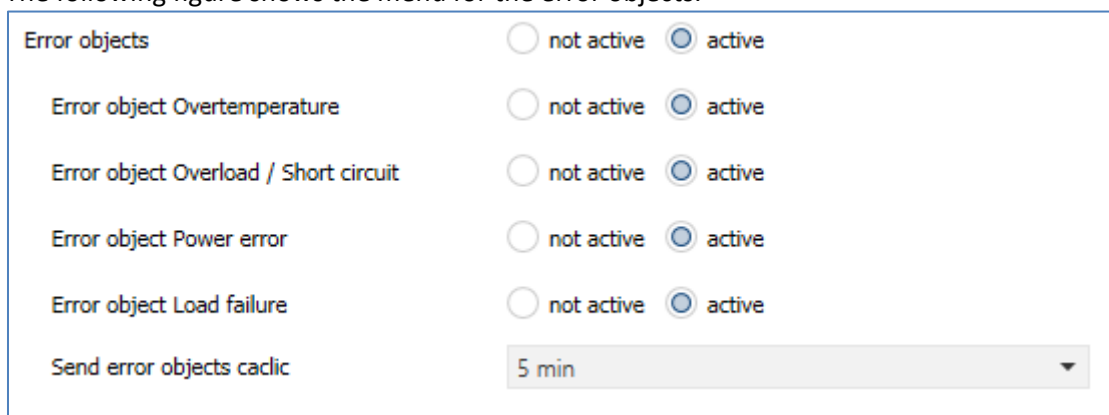

Figure 29: Settings - Error objects

The following settings can be made for the error objects:

ETS-Text	Dynamic range [Default value]	Comment
Error objects	<ul style="list-style-type: none"> ▪ not active ▪ active 	Activation / deactivation of the error objects
Error object Overtemperature	<ul style="list-style-type: none"> ▪ not active ▪ active 	Activation / deactivation of the corresponding error object
Fehlerobjekt Overload / Short circuit	<ul style="list-style-type: none"> ▪ not active ▪ active 	Activation / deactivation of the corresponding error object
Error object Power error	<ul style="list-style-type: none"> ▪ not active ▪ active 	Activation / deactivation of the corresponding error object
Error object	<ul style="list-style-type: none"> ▪ not active ▪ active 	Activation / deactivation of the corresponding error object
Send error objects cyclic	<p style="text-align: center;">not active</p> <p>5min, 10min, 20min, 30min, 60min</p>	Setting whether and how often the objects should be sent cyclically

Table 40: Settings - Error objects

The following table shows the error objects:

Number	Name	Length	Usage
23	Overtemperature	1 Bit	Indicates an overtemperature
24	Overload / Short circuit	1 Bit	Indicates an overload/short circuit
25	Power error	1 Bit	Indicates a power error
26	Load failure	1 Bit	Indicates a load failure

Table 41: Communication objects - Error objects

The error objects are output as object value 1 in case of an error. The error objects can only be output in the event of an error or cyclically.

4.4.17 Mains Filter

The following figure shows the setting for activating the mains filter:



Figure 30: Activation - Mains filter

The mains filter function can be activated or deactivated in the parameters. The mains filter is used to filter out interferences from the power supply system, such as ripple control signals, and thus ensure the best possible interference immunity.

5 Index

5.1 Register of illustrations

Figure 1: Exemplary circuit diagram AKD-0401.02.....	5
Figure 2: Exemplary circuit diagram AKD-0401.02 (Parallel operation of 2 channels each)	5
Figure 3: Overview hardware modules	6
Figure 4: General Settings	12
Figure 5: Settings - Day/Night and Time	14
Figure 6: Settings - Use of the channels	15
Figure 7: Selection - Load type	17
Figure 8: Selection of dimming curve	20
Figure 9: Dimming curves.....	20
Figure 10: Limitation of dimming range	21
Figure 11: Activation of staircase light	22
Figure 12: Settings - Staircase light function	22
Figure 13: Functional diagram - Staircase light time	24
Figure 14: Settings - Switching On/Off delay	25
Figure 15: Functional diagram - Switching On/Off delay	25
Figure 16: Settings - Switch on behaviour	26
Figure 17: Settings - Dimming speed.....	27
Figure 18: Setting - Switch channel off with relative dimming	28
Figure 19: Settings - Central objects	29
Figure 20: Settings - Block and Force functions	30
Figure 21: Activation - Scene.....	33
Figure 22: Settings - Submenu Scene.....	34
Figure 23: Settings - Bit Scenes	37
Figure 24: Settings - Submenu Time dependent dimming	39
Figure 25: Settings - Active power measurement	41
Figure 26: Settings - Active power meter.....	42
Figure 27: Activation - Diagnosis	43
Figure 28: Lamp test.....	44
Figure 29: Settings - Error objects.....	45
Figure 30: Activation - Mains filter.....	46

5.2 List of tables

Table 1: Display behavior of the green LED.....	7
Table 2: Display behavior of the red LED	7
Table 3: Possible load distribution	8
Table 4: Standard settings of the communications objects.....	11
Table 5: General Settings	13
Table 6: Communication objects - Day/Night and Time/Date.....	14
Table 7: Communication objects - Switching	16
Table 8: Communication objects - Dimming relative	16
Table 9: Communication objects - Dimming absolute.....	16
Table 10: Settings - Load type.....	17
Table 11: Overview - Setting of load type	19
Table 12: Explanation of symbols.....	19
Table 13: Settings - Dimming curve	20
Table 14: Settings - Staircase light function.....	23
Table 15: Communication objects - Staircase light function	23
Table 16: Settings - Switching On/Off delay	25
Table 17: Settings - Switch on behaviour.....	26
Table 18: Settings - Dimming speed	27
Table 19: Settings - Status output.....	28
Table 20: Settings - Send status of dimming value	28
Table 21: Communication object - State of dimming value.....	28
Table 22: Settings - Central objects.....	29
Table 23: Communication objects - Central objects	29
Table 24: Settings - Block and Force functions	31
Table 25: Communication objects - Block and Force Functions	32
Table 26: Communication object - scene	33
Table 27: Settings - Submenu Scene.....	35
Table 28: Scene call up and save.....	36
Table 29: Settings - Bit Scenes.....	37
Table 30: Communication object - Bit scenes.....	38
Table 31: Settings - Submenu Time dependent dimming	40
Table 32: Communication objects - Time dependent dimming	40
Table 33: Settings - Active power measurement.....	41
Table 34: Communication object - Active power measurement	41
Table 35: Settings - Active power meter.....	42
Table 36: Communication objects - Active power meter.....	42
Table 37: Communication object - Diagnosis	43
Table 38: Diagnosis texts	43
Table 39: Communication object - Start lamp test.....	44
Table 40: Settings - Error objects.....	45
Table 41: Communication objects - Error objects.....	45

6 Attachment

6.1 Statutory requirements

The devices described above may not be used in conjunction with devices which directly or indirectly serve human, health or life safety purposes. Furthermore, the described devices may not be used if their use may cause danger to people, animals or property.

Do not leave the packaging material lying around carelessly, plastic foil/bags etc. can become a dangerous toy for children.

6.2 Disposal routine

Do not throw the old devices in the household waste. The device contains electrical components which have to be disposed of as electronic waste. The housing consists of recyclable plastic.

6.3 Assemblage



Danger to life from electric current:

The device may only be installed and connected by qualified electricians. Observe the country-specific regulations and the applicable KNX guidelines.

The devices are approved for operation in the EU and bear the CE mark. Use in the USA and Canada is not permitted.

After installing the device and switching on the mains voltage, voltage may be present at the outputs. The outputs can be switched off using the built-in channel switch

When installed, a KNX bus telegram can switch the outputs to live at any time.

Before starting work on the device, always disconnect it from the power supply via the upstream fuses.

After installation, all live terminals and connections must be completely closed off by the control panel cover to prevent accidental contact. It may not be possible to open the panel cover without tools.

6.4 History

V1.0	First version dimming actuators, series .02	DB V2.0	06/2019
V1.1	Adaptations/extensions	DB V2.2	04/2020
V1.2	Error message “4x blinking”; new exemplary circuit diagram; Lamp test		12/2020